

# MP-225

Motorized Micromanipulator  
System

## Operation Manual

Rev. 1.70 (20150316)



**SUTTER INSTRUMENT**®

One Digital Drive  
Novato, CA 94949

Voice: 415-883-0128 Web: [www.sutter.com](http://www.sutter.com)  
Fax: 415-883-0572 Email: [info@sutter.com](mailto:info@sutter.com)



Copyright © 2015 Sutter Instrument Company. All Rights Reserved.

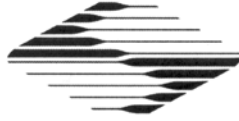

# CE EU Declaration of Conformity

Application of Council Directives:  
2014/30/EU (EMC), 2014/35/EU (LVD), and 2011/65/EU (RoHS 2)

**Manufacturer's Name:** Sutter Instrument Company

**Manufacturer's Address:** One Digital Drive  
Novato, CA. 94949 USA  
Tel: +1 415 883 0128

**Equipment Tested:** MP-225 Micromanipulator System

**Model(s):** MP225/E (controller), MP225/M (micromanipulator mechanical), & ROE225 (Rotary Optical Encoder)

**Conforms to Standards:** EMC Emissions: EN 61326-1:2013, including:  
EN 55011: 2009 Class B;  
EN 61000-3-2:2015, & EN 61000-3-3:2014  
EMC Immunity: EN 61000-4-2:2009, EN 61000-4-3:2011,  
EN 61000-4-4:2012, EN 61000-4-5:2014,  
EN 61000-4-6:2014, EN 61000-4-8:2010, &  
EN 61000-4-11:2004  
LVD (Safety): EN 61010-1:2010

**Tested/Verified By:** ITC Engineering Services, Inc.  
9959 Calaveras Road, PO Box 543  
Sunol, CA 94586-0543 USA  
Tel. +1 925 862 2944 Fax: +1 925 862 9013  
Email: [itcemc@itcemc.com](mailto:itcemc@itcemc.com) Web: [www.itcemc.com](http://www.itcemc.com)  
Sutter Instrument

**Test Report(s):** 20091104-03-CE-Rev2, 20150212-02A, SI\_EMC\_MP-225\_20160713

Sutter Instrument Company hereby declares that the equipment specified above was tested and conforms to the EU Directives and Standards listed above, and further certifies conformation to the requirements of the European Union's Restriction on Hazardous Substances in Electronic Equipment Directive 2011/65/EU (RoHS 2).

Project Engineer:

  
Jack Belgum, Ph.D.  
Senior Vice President

**SUTTER INSTRUMENT**®

One Digital Drive, Novato, CA 94949 USA Phone: +1 415 883 0128 Fax: +1 415 883 0572  
Email: [info@sutter.com](mailto:info@sutter.com) Web: <http://www.sutter.com>



## DISCLAIMER

The **MP-225** Micromanipulator is designed for the specific use of moving micropipettes in three-dimensional space in increments of micrometers into and out of an optical pathway of a microscope and no other use is recommended.

This instrument is designed for use in a laboratory environment. It is not intended for use, nor should it be used, in human experimentation or applied to humans in any way. This is not a medical device.

Do not open or attempt to repair the instrument. Extreme heat and high voltages are present and could cause injury.

Do not allow unauthorized and/or untrained operative to use this device.

Any misuse will be the sole responsibility of the user/owner and Sutter Instrument Company assumes no implied or inferred liability for direct or consequential damages from this instrument if it is operated or used in any way other than for which it is designed.

## SAFETY WARNINGS AND PRECAUTIONS



### Electrical

- Operate the MP-225 using 110-120 V AC, 60 Hz, or 220-240 V AC., 50 Hz line voltage. This instrument is designed for connection to a standard laboratory power outlet (Overvoltage Category II), and because it is a microprocessor--controlled device, it should be accorded the same system wiring precautions as any 'computer type' system. A surge protector and power regulator are recommended.
-  **Fuse Replacement:** Replace fuse only with the same type and rating as indicated in the following table.

Mains Voltage Setting	Fuse (Type: Time Delay, 5mm x 20mm, glass tube)	
	Rating	Manufacturer Examples
"110" (100 – 120 VAC)	2A, 250V (Time Delay)	Bussmann: GMC-2A, GMC-2-R (RoHS), GDC-2A, or S506-2A (RoHS) Littelfuse: 239 002 or 239.002.P (RoHS)
"220" (200 – 240 VAC)	T1.0A, 250V	Bussmann: GDC-1A or S506-1A (RoHS) Littelfuse: 218 001 or 218 001.P (RoHS)

A spare fuse is located in the power input module. Please refer to the fuse-replacement appendix for more details on fuse ratings and for instructions on how to change the fuse.

### Avoiding Electrical Shock and Fire-related Injury

-  Always use the grounded power supply cord set provided to connect the system to a grounded outlet (3-prong). This is required to protect you from injury in the event that an electrical hazard occurs.
- Do not disassemble the system. Refer servicing to qualified personnel.
-  To prevent fire or shock hazard do not expose the unit to rain or moisture.

## Electromagnetic Interference





To comply with FDA and CE electromagnetic immunity and interference standards; and to reduce the electromagnetic coupling between this and other equipment in your lab always use the type and length of interconnect cables provided with the unit for the interconnection of controller and manipulator mechanical and controller and ROE (see the TECHNICAL SPECIFICATIONS appendix for more details).



## Operational

Failure to comply with any of the following precautions may damage this device.

- This instrument is designed for operation in a laboratory environment (Pollution Degree I) that is free from mechanical vibrations, electrical noise and transients.
- This unit is not designed for operation at altitudes above 2000 meters nor was it tested for safety above 2000 meters.
- Before making electrical connections, ensure that the instrument is switched off.
-  **DO NOT CONNECT OR DISCONNECT THE CABLES BETWEEN THE CONTROLLER AND THE MECHANICAL UNITS WHILE POWER IS ON.**

Please allow at least 20 seconds after turning the unit off before disconnecting the mechanical units. Failure to do this may result in damage to the electronics.

- Operate this instrument only according to the instructions included in this manual.
- Do not operate if there is any obvious damage to any part of the instrument.
-  Operate only in a location where there is a free flow of fresh air on all sides. **NEVER ALLOW THE FREE FLOW OF AIR TO BE RESTRICTED.**
-  Do not operate this instrument near flammable materials. The use of any hazardous materials with this instrument is not recommended and if undertaken is done so at the users' own risk.
-  Do not attempt to operate the instrument with the manipulator shipping screws in place - severe motor damage may result.
-  Do not operate if there is any obvious damage to any part of the instrument. Do not attempt to operate the instrument with the manipulator shipping screws in place - severe motor damage may result. When transporting the mechanical manipulator, be sure to install the shipping screws supplied in their correct locations. Failure to do this may result in damage to the motors.
-  Never touch any part of the micromanipulator electromechanical device while it is in operation and moving. Doing so can result in physical injury (e.g., fingers can be caught and pinched between the moving parts of the micromanipulator).

-  As with all microinjection devices, sharp micropipettes can fly out of their holder unexpectedly. Always take precautions to prevent this from happening. Never loosen the micropipette holder chuck when the tubing is pressurized, and never point micropipette holders at yourself or others. Always wear safety glasses when using sharp glass micropipettes with pressure microinjectors.
-  Do not handle the manipulator mechanical while the power is on, and take care to ensure no cables pass close to the mechanical manipulator.

## Other

- Use this instrument only for microinjection purposes in conjunction with the procedures and guidelines in this manual.
- Retain the original packaging for future transport of the instrument.
- Some applications, such as piezo-impact microinjection call for the use of mercury in the micropipette tip. The use of any hazardous materials with any Sutter Instrument's instrument is not recommended and if undertaken is done so at the users' own risk.
- When transporting the mechanical manipulator, be sure to install the shipping screws supplied in their correct locations. Failure to do this may result in damage to the motors.
- This instrument contains no user-serviceable components — do not open the instrument casing. This instrument should be serviced and repaired only by Sutter Instrument or an authorized Sutter Instrument servicing agent.
- Sutter Instrument reserves the right to change specifications without prior notice.
- This device is intended only for research purposes.

## Handling Micropipettes

 Failure to comply with any of the following precautions may result in injury to the users of this device as well as those working in the general area near the device.

- The micropipettes used with this instrument are very sharp and relatively fragile. Contact with the pulled micropipette tips, therefore, should be avoided to prevent accidentally impaling yourself.
- Always dispose of micropipettes by placing them into a well-marked, spill-proof “sharps” container.

*(This page intentionally left blank.)*



## TABLE OF CONTENTS

<b>DISCLAIMER</b> .....	<b>3</b>
<b>SAFETY WARNINGS AND PRECAUTIONS</b> .....	<b>iii</b>
Electrical .....	iii
Avoiding Electrical Shock and Fire-related Injury.....	iii
Electromagnetic Interference .....	iv
Operational .....	iv
Other .....	v
Handling Micropipettes.....	v
<b>1. GENERAL INFORMATION</b> .....	<b>1</b>
1.1 Introduction.....	1
1.2 About This Manual .....	1
1.3 Technical Support.....	1
<b>2. INSTALLATION</b> .....	<b>3</b>
2.1 Unpacking.....	3
2.2 Mounting Instructions .....	3
2.2.1 Modular Construction .....	3
2.3 Electrical Connections.....	5
2.4 Instructions Used in Special Installations Only.....	6
2.4.1 Installing and Using the Right Angle Adapter (2852RA).....	6
2.5 Configuration Settings .....	6
2.5.1 Configuring Angle of Diagonal Mode Movement .....	6
2.5.2 Configuring Movement Display for each Axis when turning ROE Knob Clockwise.....	7
2.5.3 Configuring the Inclusion of Y-Axis in Home and Work Pos. Robotic Moves.....	7
<b>3. OPERATING INSTRUCTIONS</b> .....	<b>9</b>
<b>4. INSTRUCTIONS FOR CHANGING HANDEDNESS</b> .....	<b>11</b>
<b>APPENDIX A. LIMITED WARRANTY</b> .....	<b>13</b>
<b>APPENDIX B. ACCESSORIES</b> .....	<b>15</b>
<b>APPENDIX C. FUSE REPLACEMENT</b> .....	<b>17</b>
<b>APPENDIX D. TECHNICAL SPECIFICATIONS</b> .....	<b>19</b>

## TABLE OF FIGURES

Figure 2-1. Position of locking setscrews on the front of the MP-225/M. ....	4
Figure 4-1. Changing manipulator handedness. ....	11
Figure C-1. Power entry module.....	17
Figure C-2. Fuse holder.....	17

## TABLE OF TABLES

Table 2-1. Configuring the Angle of Diagonal-Mode Movements. ....	7
Table 2-2. Configuring Movement Display for Each Axis' ROE Knob Clockwise Turn.....	7
Table 2-3. Configuring the inclusion of Y-axis in Home and Work Pos. robotic moves. ....	8
Table C-1. Fuse type and rating.....	18
<b>Table D-1. Mains fuse type and rating.</b> .....	<b>20</b>
<b>Table D-2. MP-225 Controller cables and receptacles/connectors.</b> .....	<b>20</b>

# 1. GENERAL INFORMATION

## 1.1 Introduction

The MP-225 is designed primarily for positioning patch and intracellular recording pipettes. An extended version of Sutter Instrument's rotary optical encoder (ROE) is the input device for the MP-225. The system provides for a synthetic 4th axis for diagonal advancement of the pipette; and up to 16 different angles can be configured. Speed and resolution of movement are easily selected with a multiple position thumbwheel, allowing fast/coarse movement and slow/ultra-fine movement in 10 increments. Two commonly used robotic movements are incorporated for user convenience. A single button press can initiate a move to a Home position for pipette exchange or to a user-defined Work position for quick location of the pipette near the recording location.

The display on the ROE provides position location showing all three coordinates. As all controls are located on the ROE, the controller cabinet can be situated to a less-accessible area of your setup, thereby not requiring that it occupy prime space in an equipment rack

## 1.2 About This Manual

The MP-225 Micromanipulator System is comprised of three basic parts: the controller (MP-225), manipulator mechanical (MP-225/M), and a human-interface device called the ROE-225 (ROE = Rotary Optical Encoder).

In the next, few pages you will find a product description to help you become acquainted with operation, followed by installation instructions, and then detailed operating instructions. Please take the time to read these instructions to assure the safe and proper use of this instrument.

This manual is continually being updated. If you encounter any areas you feel should be covered in expanded detail we would like to hear from you. Please contact our Technical Support staff with your suggestions (415-883-0128 or [info@sutter.com](mailto:info@sutter.com)).

## 1.3 Technical Support

Unlimited technical support is provided by Sutter Instrument Company at no charge to our customers. Our technical support staff is available between the hours of 8:00 AM and 5:00 PM (Pacific Time) at (415) 883-0128. You may also E-mail your queries to [info@sutter.com](mailto:info@sutter.com).

*(This page intentionally left blank.)*

## 2. INSTALLATION

### 2.1 Unpacking

The MP-225 and associated hardware and associated hardware comes packed in a single carton. The following is a list of the components found there. If you believe that any of these components are missing or show obvious signs of damage from shipping, please contact the factory.

- Manipulator mechanical<sup>1</sup>
- Tabletop controller unit
- Extended ROE
- 25-pin cable to connect the controller with the mechanical cable adapter (the cable adapter converts the 25-pin cable to the three short modular cables that are permanently attached to the mechanical).
- 8-pin modular cable to connect the ROE with the controller
- Rod holder
- Dovetail extension (4 inches (10.16 cm))
- Mounting adapter plate
- Screws
- Hex wrench
- Power cord
- Manual\*

For detailed information on mounting our micromanipulators, refer to the Mounting Systems section or phone for assistance.

The MP-225 system is shipped to you in a prefabricated foam mold. Please take note of this method of packaging. Should it ever be necessary to ship the MP-225 to another location, the same method of packaging should be employed. Additional packing material may be purchased from Sutter Instruments Company.

**IMPORTANT: Improper packaging is a form of abuse and, as such, can be responsible for voiding the warranty where shipping damage is sustained because of such packing.**

### 2.2 Mounting Instructions

#### 2.2.1 Modular Construction

The three axes of the MP-225 are identical. They are connected to each other with tapered pegs and locking screws, four between each axis. One simply slides the pegs on the top of one axis into complimentary holes on the next to assemble a manipulator. Tightening the hex screw that threads from the side into each peg hole locks one axis to the next. The

---

<sup>1</sup> The MP-225 manipulator mechanical is set up for either right- or left-handed use. The handedness is determined when the system is ordered.

manipulator is shipped pre-assembled in either a right or a left-handed configuration. Because of the modular construction, handedness can be easily switched. In the standard configuration, the axes are stacked X, Y, and Z from bottom to top.

The manipulator mounts to its mounting adapter plate using another four tapered pegs with locking screws. See Figure 2-1 for the location of the front locking setscrews. The rear pair is in a similar location in the back of the manipulator. The manipulator is shipped with the adapter plate in place. To remove it, first loosen the hex screws that secure the manipulator to the pegs in the adapter plate. Next, pull the square mounting plate off the bottom of the manipulator. The mounting plate can be secured to any flat surface carrying  $\frac{1}{4}$ -20 or 10-32 holes on one-inch centers (such as a Sutter MT-stand or MD series platform) using the supplied hardware. Once the plate is mounted, align the pegs on top of the plate with the holes in the manipulator, push the X-axis firmly onto the plate, and re-tighten the locking hex set screws.

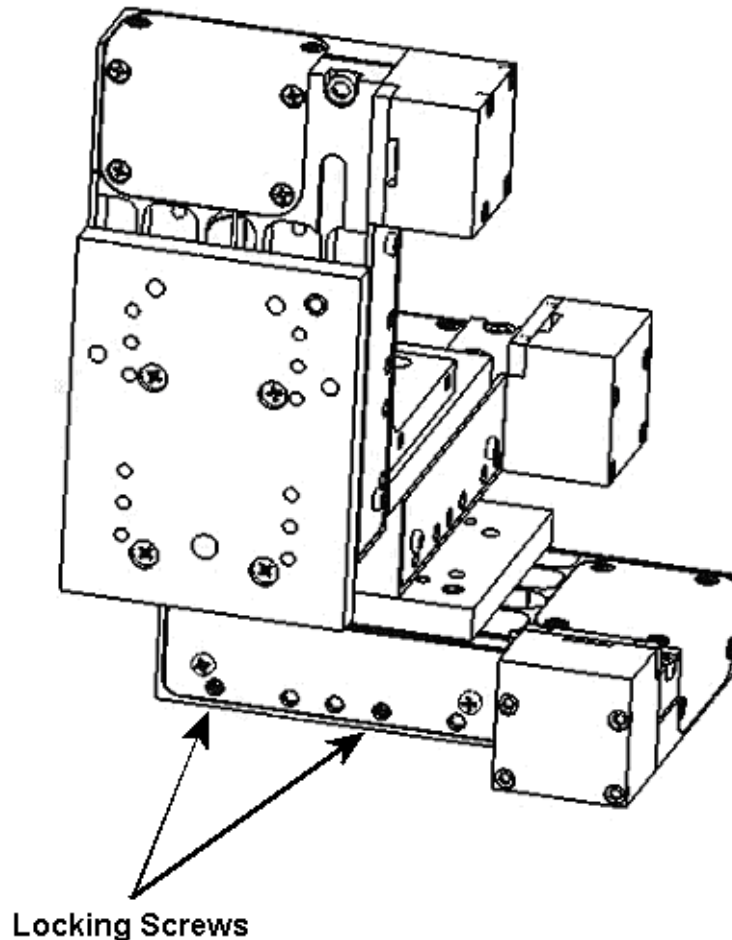

Figure 2-1. Position of locking setscrews on the front of the MP-225/M.

The modular construction allows for some flexibility in the connections between axes. In addition, the 3 axes can be used separately or assembled in non-standard configurations. **If you assemble the manipulator in other configurations, make sure that the axes do not interfere with one another!** For example, if the Z-axis is mounted in a lower location on the right angle that connects it to the Y-axis, it may interfere with the full travel of the Y-axis.

If you intend to use the right angle adapter (2852RA) with your MP-225 in order to rotate the manipulator 90 degrees, please see “Instructions used in Special Installations Only” near the end of this manual.

The rotary dovetail on the front of the MP-225 provides a mounting surface for most common headstages. Axon headstages 203B or CV-7 and the Heka EPC-10 headstage all have dovetails that fit directly into the dovetail on the manipulator. Older Axon headstages and the Heka EPC headstages are accommodated by use of a 4-inch dovetail and a plastic plate. Rod mounted headstages are accommodated by use of a rod clamp that fits into the dovetail. All the headstage adapters and mounting hardware are included with the manipulator and are located in a zip-lock plastic bag.

The angle of the rotary dovetail is adjusted by loosening the hex set screw located on the side of the swing-out gate. You can set a particular angle using the knife-edge on the dovetail and the scale on the faceplate. Tighten the screw securely to fix the angle.

To change pipettes, loosen the thumbscrew. The swing-out gate will open allowing the headstage and holder to rotate almost 90 degrees. Make sure to swing the gate tightly closed and tighten the thumbscrew securely while holding the gate closed. The thumbscrew is designed to pull the gate closed with tightening. Thumb and finger tightening is sufficient.

The height of the swing-out gate on the front of the Z-axis is adjustable. To change the position, open the gate and loosen the 4 Phillips-head screws that mount the swing gate. As shipped from the factory, the gate is positioned to allow access to the shipping screw holes. You may find it beneficial to move the gate up before you start using your MP-225.

## 2.3 Electrical Connections

You will find three cables supplied with your MP-225: a power cable, a DB-25 cable, and a modular 8-pin cable similar to that used in telecommunications. In addition, three short modular cables are permanently attached to the manipulator mechanical unit. The other pieces of the unit are the controller (large beige rectangular box with on/off switch), the ROE (the black trapezoidal box with three knobs and 5 buttons), and the connector box (small, black rectangular box with three modular connectors and one DB-25 connector).

First, connect one end of the power cable to the controller (beige box) and the other to a source of power. You may need to change the power-input module to the correct line input voltage (110 or 220VAC). The units are normally configured for the shipping destination, but you should check to make sure this switch is correct. It can be changed using a small, straight-blade screwdriver.

Next, connect the ROE input box to the controller using the black, 8-pin modular cable.

Finally, connect the manipulator mechanical to the connector box by connecting its three modular wires to the appropriate modular connectors on the box. Connect the connector box to the controller using the beige DB-25 cable. In principle, you can connect the cable from any mechanical axis to any of the three connectors on the connector box, but Sutter conventions will only be preserved if the X, Y, and Z axes are plugged in to the corresponding X, Y, and Z outputs on the connector box. Looking at the manipulator mechanical with the rotary dovetail facing you, the Z-axis moves up and down (pipette in and out of focus), the X-axis moves left and right (pipette moving axially), and the Y-axis moves toward and away from you (pipette laterally).

## **2.4 Instructions Used in Special Installations Only**

### **2.4.1 Installing and Using the Right Angle Adapter (2852RA)**

Open the swing-out gate and remove it from the front of the MP225 by removing the four Phillips-head screws. Next, install the right angle adapter on the front of the MP225 using the supplied M3-0.5 hex head screws. Finally, install the swing out gate on the right angle adapter using the four Phillips-head screws. With the right angle in place, the manipulator (right handed) can be turned 90 degrees clockwise so that its bulk faces to the right instead of the back of your microscope.

Having made the 90-degree rotation, if you wish to use the automated features and diagonal movement mode of the MP225, two other minor changes must be made:

First, as the X and Y-axes have interchanged with the 90-degree rotation, the wires controlling these two axes must be switched at the connector box.

Second, in order to have the Y axis movement be in the forward direction during the home move, you need to rotate the Y axis 180 degrees with respect to the rest of the manipulator. To reverse the Y (bottom axis in the rotated configuration), locate and loosen the 4 set screws that attach the Y to the X. These are on the sides of the X or middle axis in the stack. When the set screws are loose, you can move the Y off the X, rotate it 180 degrees and reinsert its mounting posts into the correct holes in the X (the holes with set screws). Finally, press the two axes firmly together and re-tighten the setscrews. Now the Y-axis will move forward during the home move and back during the work position move.

## **2.5 Configuration Settings**

The DIP (Dual Inline Package) switches are located on the back of the extended ROE box. They are numbered 1 through 8. In all cases, the 0 or off position is in the direction of the switch number and the 1 or on position is in the opposite direction and is also indicated by an arrow and the word “ON” next to Switch 1. In order for any new switch settings to take effect, the controller must be powered off and on.

### **2.5.1 Configuring Angle of Diagonal Mode Movement**

**DIP Switches 1, 2, 3 and 4** set the angle of the Diagonal mode movement.

The table gives the angles that can be used and the DIP-switch settings of switches 1,2,3 and 4.



Table 2-1. Configuring the Angle of Diagonal-Mode Movements.

Diagonal Mode Movement Angle	DIP Switch Number				Comments	
	1	2	3	4		
Angles equal to or less steep than 45°	7	1	1	1	1	
	11	0	1	1	1	
	14	1	0	1	1	
	21	0	0	1	1	
	27	1	1	0	1	
	29	0	1	0	1	*Factory default (close to 30°)
	35	1	0	0	1	
	39	0	0	0	1	
Angles steeper than 45°	45	1	1	1	0	
	39	0	1	1	0	
	35	1	0	1	0	
	29	0	0	1	0	
	27	1	1	0	0	
	21	0	1	0	0	
	14	1	0	0	0	
11	0	0	0	0		

### 2.5.2 Configuring Movement Display for each Axis when turning ROE Knob Clockwise

DIP Switches 5, 6 and 7 set the direction of the movement produced by a clockwise turn (advancing right hand screw) of the ROE knob for each axis.

With the switch set to 0, a clockwise turn of the knob produces a decrement in the display, when the switch is set to 1, a clockwise turn of the knob produces an increment in the display. An increment in the display coincides with movement downward in the Z-axis, movement toward the rear of your setup in the Y-axis and movement producing pipette advancement in the X-axis.

The factory default is 1,1,1 for switches 5,6 and 7.

Table 2-2. Configuring Movement Display for Each Axis' ROE Knob Clockwise Turn.

DIP Switch Number	5		6		7	
Corresponding Axis	X		Y		Z	
Switch Position	0	1	0	1	0	1
Displayed Movement	Decrement	Increment	Decrement	Increment	Decrement	Increment

### 2.5.3 Configuring the Inclusion of Y-Axis in Home and Work Pos. Robotic Moves

DIP Switch 8 determines whether or not the Y-axis is included in Home and Work Pos. robotic moves.

If switch 8 is set to 0, the Y axis is moved to a location where the pipette is towards the user in Home move and is moved back to whatever Y coordinate was recorded during Set-Work Pos. in the Work Pos. move. If switch 8 is set to 1, the Y axis is not moved (Y position

ignored) during the Home or Work Pos. moves. The factory default for switch 8 is 0 (the Y axis will move during Home and Work Pos. moves).

Table 2-3. Configuring the inclusion of Y-axis in Home and Work Pos. robotic moves.

<b>DIP Switch 8</b>	<b>Include Y-Axis in Home and Work Pos. Robotic Moves</b>
0	Yes
1	No

### 3. OPERATING INSTRUCTIONS

Once the electrical connections have been made, you can power up the unit using the on/off switch on the front of the controller. As it initializes, it will briefly display the version of the installed firmware. As the power switch is the only control you will need to access on the controller, it can be placed in an out of the way location (e.g. under your bench).

All functions necessary during normal operation are provided by 5 push buttons, a MODE Selector and three rotary optical encoder (ROE) knobs located on the ROE input box. Other set-up functions are done via DIP switches located on the back of the ROE box.

The three ROE knobs control the three axes of the manipulator (right knob X, left knob Y, and top knob Z). The direction of movement commanded by a clockwise turn of the knob is controlled by a DIP switch (one for each axis) located on the back of the ROE. (See DIP switch setting instructions).

The MODE Selector changes the speed and the relative fineness of movement of the manipulator when rotating the ROE knobs. Setting 0 is for course movement at high speed and setting 9 is for very fine movement at very slow speed. In practice, most users will find that speed 5 or 6 will provide the necessary fineness of movement for approaching cells. The current MODE setting is displayed in the upper right of the ROE display.

**The five push buttons have the following functions:**

**Stop/Set:** When held down, the “Stop/Set” button performs a “Set” function in combination with either the “Work Pos.” or “Center” keys (see below). Think of it as a shift key when held down.

Pressing the “Stop/Set” button during a robotic move (see “Center”, “Home”, and “Work Pos.” below) will immediately “Stop” the movement. **Think of this as your panic button when you see your pipette headed somewhere that you don’t want it to go! If you have used the “Stop” button to stop robotic movement, you need to cycle the power off/on and then run Center (see below) to completely recover normal function.**

**Diag/Norm:** Pressing the “Diag/Norm” button will cause the green LED to light, indicating the MP-225 is in Diagonal mode. When in this mode, rotation of the Z-axis knob produces diagonal movement. A second press will put the MP-225 back into Normal mode. When in diagonal mode, the X and Y knobs remain active, allowing you to re-adjust the X and Y positioning of the pipette as you approach a cell in diagonal mode. Angle of diagonal mode movement is set via DIP switches on the back of the ROE box. (See DIP switch setting instructions). When using MODE 9 (rotary thumb wheel set to 9) Diagonal mode produces short, quick, impulse-like movement that may be useful in sharp pipette impalements.

**Home:** When pressed, the manipulator will make a move to a factory determined “Home” location along a stereotypic path. The Home location is defined as the location where you would most likely exchange your pipette. It is coordinate 0,0,0 and is maximal up on the Z-axis, maximal right on the X-axis (maximal left on a left-handed manipulator) and maximal front on the Y-axis. The path of the movement is first along the currently set diagonal until either the X-axis or Z-axis reaches its origin (0). Which one of these occurs first is a function of the diagonal angle and the location at the time “Home” is pressed. Once the first limit is reached, the unit will move the two remaining axes simultaneously to their origins (0). The

one allowed change in this stereotyped move is that the Y-axis move can be eliminated. This is done via a DIP switch on the back of the ROE. (See DIP switch setting instructions).

**Work Pos.:** The Work Pos. button has two functions. When the “Set” button is held down, pressing and releasing “Work Pos.” makes the current location the “Work Position”. A beeper will sound to indicate that the operation is complete and the current location has been saved. Typically, this will be a location where the pipette tip is near your preparation (cells or tissue of interest). When “Work Pos.” is pressed alone, after a Work Pos. has been set and after the manipulator has just made a move to “Home”, then the manipulator will move to the preset work position. The move will occur along the predefined path that the manipulator moved to get to “Home” as described above, but in the opposite direction. This is the reason why “Work Pos.” moves must follow “Home” moves as the move to Home defines the return trip. In either case, the movement along the diagonal as you come in and out of the preparation/dish/bath should assure that the pipette tip cannot hit anything on the way in or out.

**Center:** Center is a function that will normally only be used when the unit is first set up. The Center move should only be done in the absence of a pipette as the manipulator makes large robotic movements to its extreme ranges of motion. To activate Center, press “Set” and while holding it down press and release “Center”. This will cause a prolonged movement in each axis to the end of travel (EOT) sensors beyond the origin (0,0,0). Once the sensors are found, a short move in the opposite direction is made and this location is defined as (0,0,0). Finally, the unit moves to the location (12500, 12500, 12500). This is equivalent to the center of travel of each axis. Once the Center function has been run, each axis is limited (in firmware) to movement between 0 to 25000 microns. As the EOT sensors are located just beyond these soft limits, you should never reach the hardware end of travel. If an axis does travel past the EOT sensor, you will see EOT on the display of the ROE. If this occurs, it is a good idea to run the Center routine again to re-establish the soft limits. You should turn the unit off and back on before running the Center routine. If you find you need to run the center routine often (seeing EOT soon after running Center), you should contact Sutter Instrument Company for advice.

## 4. INSTRUCTIONS FOR CHANGING HANDEDNESS

To switch the MP-225/M from **right-handed** to **left-handed**:

1. Loosen four hex set screws, two on each side of the Y axis, that lock four tapered pins on the top of the X-axis in the holes in the bottom of the Y-axis (the four screws are indicated in the left and right panels below).
2. Pull the X-axis straight down (left panel).
3. Rotate the X-axis 180 degrees in the X-Y plane so that the motor and wire of the X-axis are on the left side of the manipulator (middle panel).
4. Reinsert the pins into the holes in the bottom of the Y-axis (right panel).
5. Retighten the hex set screws in the sides of the Y-axis.
6. Open the swing gate and remove the four screws that attach it to the Z-axis.
7. Rotate the swing gate 180 degrees in the Z-X plane and reattach to the front of the Z-axis.
8. Remove the thumbscrew from the bottom of the swing gate and install in the similar hole in the top of the swing gate (rotated swing gate shown in right panel).

To switch from left to right, simply reverse these directions.

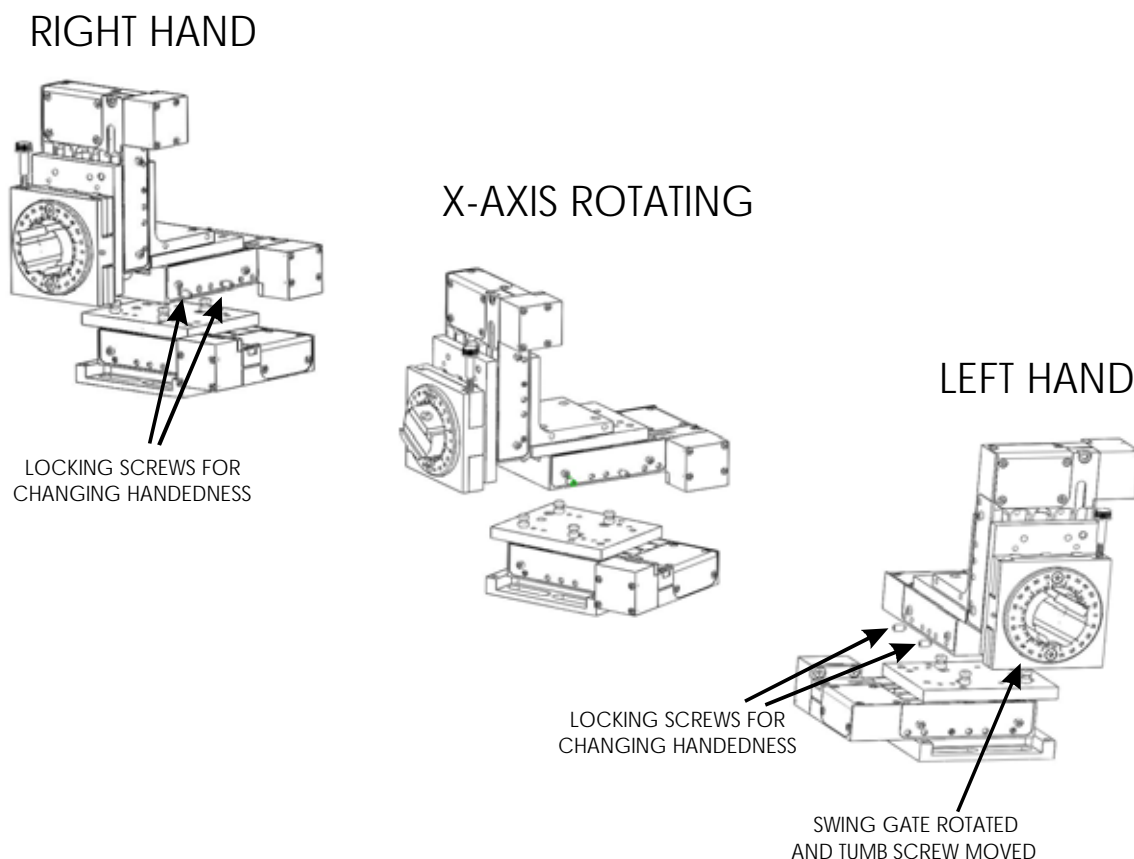

Figure 4-1. Changing manipulator handedness.

*(This page intentionally left blank.)*

## APPENDIX A. LIMITED WARRANTY

- Sutter Instrument Company, a division of Sutter Instrument Corporation, limits the warranty on this instrument to repair and replacement of defective components for two years from date of shipment, provided the instrument has been operated in accordance with the instructions outlined in this manual.
- Abuse, misuse, or unauthorized repairs will void this warranty.
- Warranty work will be performed only at the factory.
- The cost of shipment both ways is paid for by Sutter Instrument during the first three months this warranty is in effect, after which the cost is the responsibility of the customer.
- The limited warranty is as stated above and no implied or inferred liability for direct or consequential damages is intended.
- Consumables, PMTs, galvanometers, and Uniblitz<sup>®1</sup> shutters are exempt from this warranty.
- An extended warranty for up to three additional years can be purchased at the time of ordering, or until the original warranty expires. For pricing and other information, please contact Sutter Instrument.

---

<sup>1</sup> Uniblitz<sup>®</sup> is a registered trademark of Vincent Associates.

*(This page intentionally left blank.)*



## APPENDIX B. ACCESSORIES

The following accessories are available for the MP-225.

<b>285204</b>	4 inch dovetail extension
<b>285210<sup>1</sup></b>	Mounting adapter plate
<b>225RBI</b>	Rotating base for MP-225
<b>X285300</b>	Right angle adapter
<b>X285305</b>	Z-axis vertical extension
<b>X285310</b>	Z-axis horizontal extension
<b>BR-AW</b>	Rod-holding clamp for XenoWorks <sup>®2</sup> injectors
<b>MP-ROD</b>	Rod holder
<b>285HEA</b>	Hinged headstage mount
<b>M100106</b>	Flat side panel for controller

---

<sup>1</sup> For use with MT- or MD-series stands/platforms, or any surface with 1-inch centered holes.

<sup>2</sup> XenoWorks<sup>®</sup> is a registered trademark of Sutter Instrument Company.

*(This page intentionally blank.)*

## APPENDIX C. FUSE REPLACEMENT

In the event that the controller fails to power up when the power switch is turned on, check the line power fuse to see if it has blown. The fuse is located in the fuse holder on the power entry module on the back of the controller. To remove the fuse holder first unplug the power cord from the power entry module. This will reveal a slot just under the edge of the fuse holder. Use a screwdriver to pry the holder straight out of the power entry module.

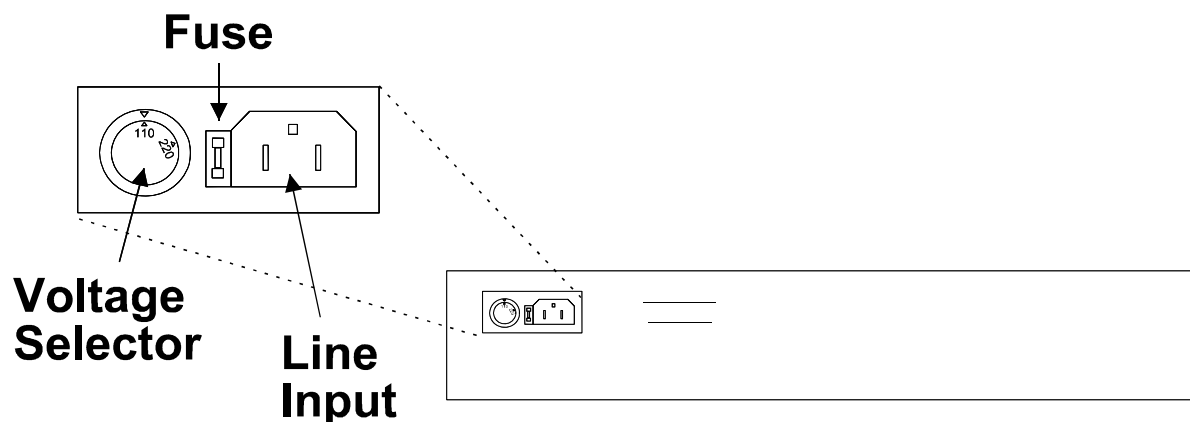

Figure C-1. Power entry module

The fuse that is readily visible in the fuse holder when you take it out is the one that is “active” when the holder is installed. A spare fuse is also stored within the fuse holder. It is concealed in a compartment as shown in Figure C-2. To remove the spare fuse, press down on the end of the compartment and push it out of the other end. The old fuse can serve as a convenient tool for pushing the spare fuse compartment out. Replace the active fuse with the spare and re-install the fuse holder and power cord. If the controller fails to power up with the new fuse installed, call Sutter Instrument technical support personnel for assistance.

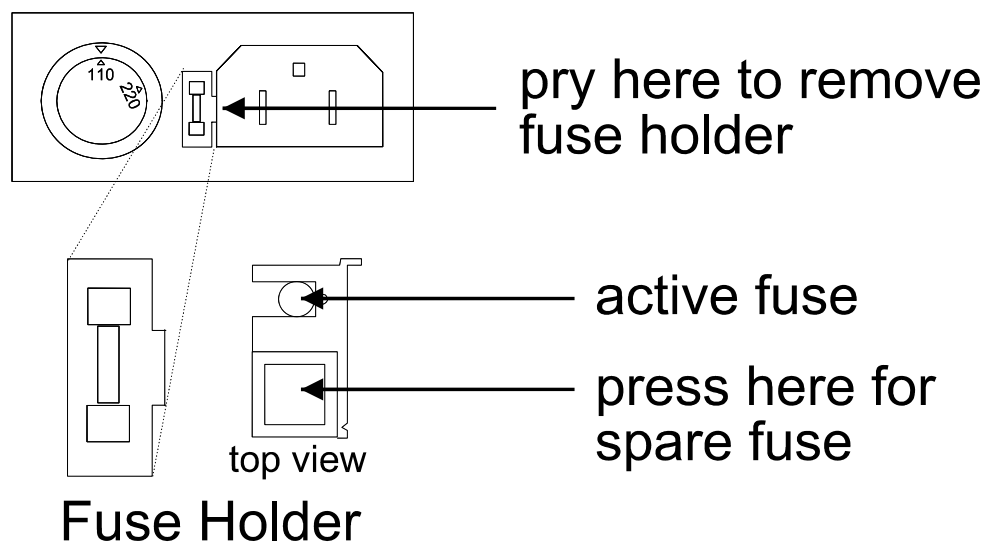

Figure C-2. Fuse holder.

Make certain that the type and rating of the fuse being replaced are as indicated in Table C-1, according to the mains voltage setting being used.

Table C-1. Fuse type and rating.

Mains Voltage Setting	Fuse (Type: Time Delay, 5mm x 20mm, glass tube)	
	Rating	Manufacturer Examples
“110” (100 – 120 VAC)	2A, 250V (Time Delay)	Bussmann: GMC-2A, GMC-2-R (RoHS), GDC-2A, or S506-2A (RoHS) Littelfuse: 239 002 or 239.002.P (RoHS)
“220” (200 – 240 VAC)	T1.0A, 250V	Bussmann: GDC-1A or S506-1A (RoHS) Littelfuse: 218 001 or 218 001.P (RoHS)

## APPENDIX D. TECHNICAL SPECIFICATIONS

RoHS Compliant 

<b>Travel:</b>	<b>25 mm (1 in) on all three axes</b>
<b>Resolution:</b>	
<b>Selectable microstep sizes:</b>	<b>Six: 0.0625, 0.125, 0.25, 0.5, 1.0 and 2.0 (<math>\mu\text{m}/\mu\text{step}</math>)</b>
	<b>Finer movement settings use the 62.5nm microstep size but fewer microsteps are commanded per encoder knob turn</b>
<b>Maximum Speed:</b>	<b>2.0mm/sec (0.08 in/sec)</b>
<b>Long Term Stability:</b>	<b>1-2 <math>\mu\text{m}/\text{hour}</math> maximum</b>
<b>Drive Mechanism:</b>	<b>Integral miniature stepper motor anti-backlash gear head</b>
<b>Dimensions: (H x W x D):</b>	
<b>MP-225/M Manipulator:</b>	<b>5.5 x 4 x 6 in (15 x 10 x 15.5 cm)</b>
<b>MP-225/E Controller:</b>	<b>16 x 4 x 12.25 in (40.5 x 10 x 31 cm)</b>
<b>ROE-225 Rotary Optical Encoder</b>	<b>4 x 5 x 9 in (10 x 13 x 23 cm)</b>
<b>Weight:</b>	
<b>MP-225/M Manipulator:</b>	<b>2.95 lb (1.3 kg)</b>
<b>MP-225/E Controller:</b>	<b>10 lb (4.5 kg.)</b>
<b>ROE-225 Rotary Optical Encoder</b>	<b>3.118 lb (1.42 kg)</b>
<b>Electrical:</b>	
<b>Input voltage (Mains):</b>	<b>100 – 120 VAC, 50/60 Hz 200 – 240 VAC, 50/60 Hz</b>

**Mains fuse (rear of cabinet):**

**Table D-1. Mains fuse type and rating.**

Mains Voltage Setting	Fuse (Type: Time Delay, 5mm x 20mm, glass tube)	
	Rating	Manufacturer Examples
“110” (100 – 120 VAC)	2A, 250V (Time Delay)	Bussmann: GMC-2A, GMC-2-R (RoHS), GDC-2A, or S506-2A (RoHS) Littelfuse: 239 002 or 239.002.P (RoHS)
“220” (200 – 240 VAC)	T1.0A, 250V	Bussmann: GDC-1A or S506-1A (RoHS) Littelfuse: 218 001 or 218 001.P (RoHS)

**Cables**

(Refer to the following two tables for a description of all possible cables.)

**Table D-2. MP-225 Controller cables and receptacles/connectors.**

Controller Rear Panel Port Connector/Receptacle	Cable Connector Types	Connects to ...	Cable Type	Cable Max. Length
(Power entry) 3-pin male connector	←3-pin power standard (female)   3-pin male→ (Geographical region dependent)	Mains power source.	10A, 250V, with safety ground plug	3 meters (approx. 10 feet)
DRIVE MODULE (25-Pin DSUB female receptacle)	←DB-25 male   DB-25 female→ (straight-through)	MP-225M adapter (25-Pin DSUB male connector) (MP-225M Adapter has three RJ45 connectors for three cables that connect to the MP-225M electromechanical)	Minimum of 26 awg stranded wire with 500 Volt (see note)	3 meters (approx. 10 feet)
INPUT MODULE (RJ45 receptacle)	RJ45 male   RJ45 male	ROE-225 (RJ45 receptacle)		3 meters (approx. 10 feet)

**NOTE::** A ferrite at the controller end is strongly recommended (Fair-Rite part number 0443164-251). Fair-Rite Products Corp., P.O. Box J, One Commercial Row, Walkill, NY, 12589, USA

## INDEX

### *C*

controller  
cable specs ..... 20

### *D*

dimensions..... 19  
disclaimer ..... iii

### *E*

electrical  
specifications ..... 19

### *F*

fuse  
holder ..... 17  
location ..... 17  
mains..... 20  
replacement..... 17  
spare..... 17  
fuses, replacement  
mains..... iii

### *G*

glassware  
precautions.....v

### *I*

installation  
mounting instructions.....3  
unpacking.....3

### *M*

mains  
fuse ..... 20  
fuses ..... iii  
voltage..... 19  
modular construction .....3  
mounting instructions.....3

### *N*

notes  
user..... 22

### *P*

packaging.....3

power entry module..... 17  
precautions..... iii  
electrical..... iii

### *R*

resolution..... 19

### *S*

safety warnings..... iii  
electrical..... iii  
safety warnings & precautions  
operational.....iv  
safety warnings & precautions..... iii, iv  
**specifications** ..... 19  
cables..... 20  
dimensions..... 19  
drive mechanism..... 19  
electrical..... 19  
cables..... 20  
input voltage (mains) ..... 19  
mains fuse..... 20  
maximum power consumption ..... 20  
long term stability ..... 19  
maximum speed ..... 19  
resolution..... 19  
**microstep sizes** ..... 19  
travel..... 19  
weight ..... 19

### *T*

**technical specifications**..... 19  
technical support .....1  
travel ..... 19

### *U*

unpacking .....3

### *V*

voltage  
mains..... 19

### *W*

warranty ..... 13  
weight ..... 19

## NOTES