

OPERATING INSTRUCTIONS AND SYSTEM DESCRIPTION FOR THE

PTC-10

PELTIER TEMPERATURE CONTROL SYSTEM



VERSION 4.0
npi 2017

npi electronic GmbH, Bauhofring 16, D-71732 Tamm, Germany
Phone +49 (0)7141-9730230; Fax: +49 (0)7141-9730240
support@npielectronic.com; <http://www.npielectronic.com>

Table of Contents

1. Safety Regulations.....	3
2. PTC-10 Components	4
3. PTC-10 System.....	4
3.1. System Description.....	4
3.2. Description of the Front Panel.....	5
3.3. Rear Panel Elements.....	10
3.4. Electronic Control and Protection Circuits.....	10
3.5. Connection of Peltier Elements	11
3.6. Modes of Operation.....	11
3.7. Setting the DESIRED TEMPERATURE.....	13
4. Grounding.....	13
5. Temperature sensors / Block diagram	14
5.1. DIN Connector	14
5.1. Available sensors.....	15
5.2. Block diagram	16
6. Operating guide – Tuning procedure.....	17
6.1. PTC-10 and the HCMIS Micro-Incubator.....	19
Connection.....	19
Operation	19
6.2. Operation with HPT-2A heated perfusion tube (discontinued).....	20
7. Literature	20
8. Technical Data.....	21

1. Safety Regulations

VERY IMPORTANT: Instruments and components supplied by npi electronic are NOT intended for clinical use or medical purposes (e.g. for diagnosis or treatment of humans), or for any other life-supporting system. npi electronic disclaims any warranties for such purpose. Equipment supplied by npi electronic must be operated only by selected, trained and adequately instructed personnel. For details please consult the **GENERAL TERMS OF DELIVERY AND CONDITIONS OF BUSINESS** of npi electronic, D-71732 Tamm, Germany.

- 1) **GENERAL:** This system is designed for use in scientific laboratories and must be operated by trained staff only. General safety regulations for operating electrical devices should be followed.
- 2) **AC MAINS CONNECTION:** While working with the npi systems, always adhere to the appropriate safety measures for handling electronic devices. Before using any device please read manuals and instructions carefully.
The device is to be operated only at 115/230 Volt 60/50 Hz AC. Please check for appropriate line voltage before connecting any system to mains.
Always use a three-wire line cord and a mains power-plug with a protection contact connected to ground (protective earth).
Before opening the cabinet, unplug the instrument.
Unplug the instrument when replacing the fuse or changing line voltage. Replace fuse only with an appropriate specified type.
- 3) **STATIC ELECTRICITY:** Electronic equipment is sensitive to static discharges. Some devices such as sensor inputs are equipped with very sensitive FET amplifiers, which can be damaged by electrostatic charge and must therefore be handled with care. Electrostatic discharge can be avoided by touching a grounded metal surface when changing or adjusting sensors. **Always turn power off when adding or removing modules, connecting or disconnecting sensors, headstages or other components from the instrument or 19" cabinet.**
- 4) **TEMPERATURE DRIFT / WARM-UP TIME:** All analog electronic systems are sensitive to temperature changes. Therefore, all electronic instruments containing analog circuits should be used only in a warmed-up condition (i.e. after internal temperature has reached steady-state values). In most cases a warm-up period of 20-30 minutes is sufficient.
- 5) **HANDLING:** Please protect the device from moisture, heat, radiation and corrosive chemicals.

PELTIER ELEMENTS MUST BE MOUNTED ALWAYS ON APPROPRIATE HEAT SINKS TO AVOID DAMAGE THROUGH OVERHEATING.

2. PTC-10 Components

The following items are shipped with the PTC-10 system:

- ✓ PTC-10 controller
- ✓ Power cord
- ✓ User manual

Optional accessories:

- ⇨ COOLIT heat sink for heating and cooling devices
- ⇨ Miniature temperature sensor
- ⇨ Subminiature temperature sensor

Caution: The temperature sensors are very sensitive to mechanical stress, especially to bending. Therefore, they must be handled with great care to avoid breaking of the insulation!

- ⇨ PT 100 temperature sensor
- ⇨ HCMIS microincubator
- ⇨ HCPC heating/cooling perfusion cube
- ⇨ HCS heated chamber stage
- ⇨ HPC Heated perfusion cube
- ⇨ Thermal foil
- ⇨ Objective heater

3. PTC-10 System

3.1. System Description

The PTC-10 temperature control system is designed for heating and cooling purposes in electrophysiological experiments. The PTC-10 system provides a temperature controller channel and is housed in a 19 inch standard rackmount cabinet with built-in power supply and cooling elements for the power devices. The PTC-10 system guarantees low noise operation and has special protection features to prevent the preparation from damage.

The PTC-10 system incorporates two electronic thermometers for small semiconductor sensor (standard is R2252, i.e. the sensor has a resistance of 2252 Ω at 25 °C or optionally, PT 100, i.e. 100 Ω at 0 °C), two digital temperature displays (XX.X °C), a set value control with direct readout (XX.X °C), a PI (proportional-integral) controller with adjustable parameters, an output power control unit and a high-power bipolar output stage (± 12 V DC, continuous operation) for Peltier elements (i.e. heating / cooling operation) or resistive (i.e. heating only) loads with electronic protection circuits. For heating-only applications the bipolar output can be switched to unipolar operation (+12 V). The power output is short circuit protected, the output power is limited electronically. Maximum output voltage is approximately ± 12 V, the current is limited to 5 A (peak current only). In continuous operation the current is limited to 3.5 A.

The system can be connected to the thermistors / heating / Peltier elements in two ways:

- Using separate cables for the sensors and the heating / Peltier element or
- Using the ALA DIN cable assembly that connects both, sensors and heating / Peltier elements

A large variety of sensors and thermal elements are available (see also **Optional accessories** in chapter 2). Please contact npf for details.

Important: Peltier elements must be mounted always on appropriate heat sinks to avoid damage because of overheating.

3.2. Description of the Front Panel

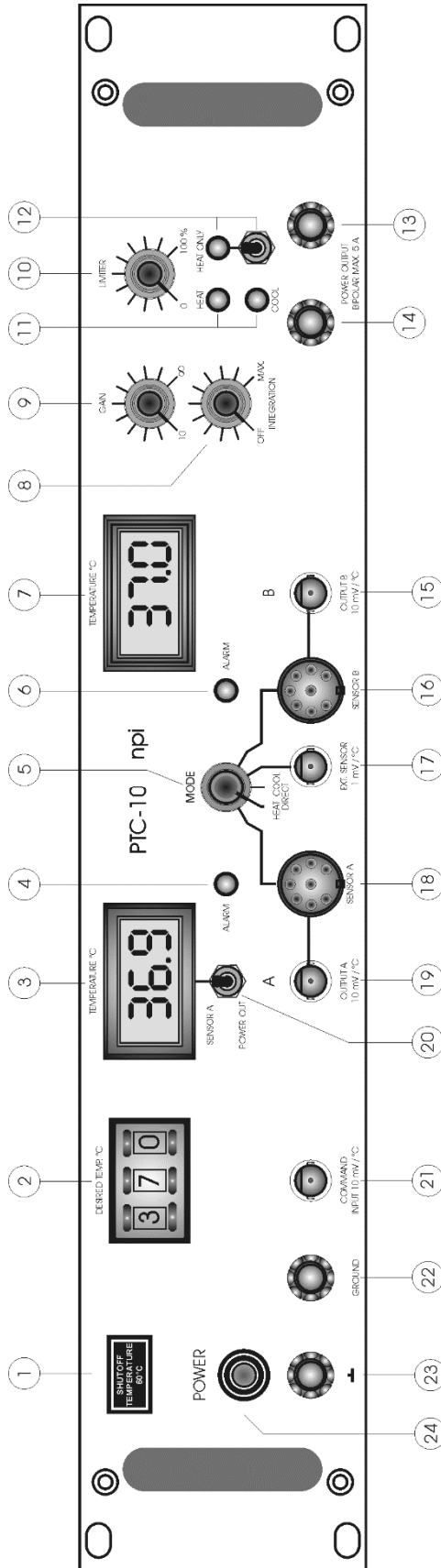

Figure 1: PTC-10 front panel view

In the following description of the front panel elements each element has a number that is related to that in Figure 1. The number is followed by the name (in uppercase letters) written on the front panel and the type of the element (in lowercase letters). Then, a short description of the element is given.

(1) SHUTOFF TEMPERATURE label



Label indicating the upper SHUTOFF TEMPERATURE (standard is 60 °C). If the sensor measures the indicated temperature or more the POWER OUTPUT is disabled.

(2) DESIRED TEMP./°C potentiometer



Digital potentiometer to set the working temperature of the controller system, range: 02.0 °C to 60.0 °C, XX.X °C or 0-100% of output voltage (DIRECT mode).

Display A unit



The **Display A unit** consists of **(3) TEMPERATURE °C A display** and **(20) SENSOR A / POWER OUT switch**

(3) TEMPERATURE °C A display

Digital display showing the temperature determined by SENSOR A (**18**) or the voltage at the POWER OUTPUT connectors (**13 / 14**). Switch (**20**) is used to select one of these functions of display A.

(20) SENSOR A / POWER OUT switch (display mode switch)

Switch to select the mode of display A (**3**):

SENSOR A (upper position): the temperature determined by SENSOR A (**18**) is displayed (XX.X °C)

PWR OUT (lower position): the voltage at the POWER OUTPUT (**13 / 14**) is displayed.

(4) ALARM LED

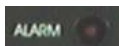

LED indicating that temperature SENSOR A (**18**) is not connected, broken or short-circuited, or that the measured temperature goes beyond the shutoff temperature (see also **24**). The POWER OUTPUT (**13 / 14**) shuts down if this LED is on and the MODE switch (**5**) is set to SENSOR A.

MODE of operation unit channel A

The MODE of operation unit of channel A consists of **(5)** MODE switch, **(17)** EXT.SENSOR 1mV / °C connector, **(18)** SENSOR A connector, **(16)** SENSOR B connector

(5) MODE switch

Switch to select the operation modes of the PTC-10. Five modes are available:

SENSOR A: the temperature determined by SENSOR A **(18)** is used for the control system. This connector also provides the POWER OUTPUT **(13 / 14)** for the heating unit / Peltier element (max. 12 V DC and 5A) for devices with the ALA DIN connector cable assembly. (e.g. HCMIS, see www.alascience.com).

DIRECT HEAT: the voltage at the POWER OUTPUT **(13 / 14)** can be set directly from the DESIRED TEMP. potentiometer **(2)** (0 - ±12 V, no control). Works correct only if the Peltier element is connected with right polarity (see chapter 3.5).

DIRECT COOL: the voltage at the POWER OUTPUT **(13 / 14)** can be set directly from the DESIRED TEMP. potentiometer **(2)** (0 - ±12 V, no control). Works correct only if the Peltier element is connected with right polarity (see chapter 3.5).

EXT. SENSOR (EXTERN SENSOR): an external thermometer connected to BNC **(17)** (sensitivity: 1mV / °C) is used for the controller loop

SENSOR B: temperature determined by SENSOR B **(16)** is used as feedback temperature in the controller loop. This connector also provides the POWER OUTPUT **(13 / 14)** for the heating unit / Peltier element (max. 12V DC and 5A) for devices with the ALA DIN connector cable assembly. (e.g. HCMIS, see www.alascience.com).

(17) EXT. SENSOR 1mV/°C connector

BNC connector to connect external thermometer with a voltage output of 1mV/°C (see also **(5)**).

(18) SENSOR A connector

8-pole connector for temperature SENSOR A.

(16) SENSOR B connector

8-pole connector for temperature SENSOR B.

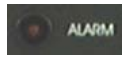
(6) ALARM LED

LED indicating that temperature SENSOR B (**16**) is not connected, broken or short-circuited or that the measured temperature goes beyond the shutoff temperature (see also **24**). The POWER OUTPUT (**13 / 14**) shuts down if this LED is on and the MODE switch (**5**) is set to SENSOR B.

(7) TEMPERATURE °C B display

Digital display showing the temperature determined by SENSOR B (**16**).

(8) INTEGRATION potentiometer

Potentiometer to set the INTEGRATION parameter (time constant) of the temperature controller (PI controller), time range: 50 ms - 20 s.

(9) GAIN potentiometer

Potentiometer (logarithmic scale) to change the GAIN parameter (amplification of the error signal, see chapter 3.4) of the temperature controller (PI controller), range: 10 to ∞ .

(10) LIMITER potentiometer

Potentiometer to set the voltage range of the POWER OUTPUT (**13 / 14**), 100% = ± 12 Volt.

(11) HEAT / COOL LEDs

LEDs that indicate the state of the POWER OUTPUT (**13 / 14**).



HEAT (yellow LED): output polarity positive ("active" side will be heated, see also chapter 3.5)

COOL (green LED): output polarity negative ("active" side will be cooled, see also chapter 3.5)

(12) HEAT ONLY LED, HEAT ONLY switch

Toggle switch for setting the controller into HEAT ONLY mode. The red LED indicates the state of the controller (LED on = HEAT ONLY).

(13) / (14) POWER OUTPUT Max. 5A connectors

Banana jack connectors for the Peltier element. Red jack **(13)** supplies positive voltage for heating and negative voltage for cooling. The “active” side of the Peltier element is connected here (see also chapter 3.5). This output supplies a maximum voltage of $\pm 12\text{V DC}$ and a maximum current of 5A. Blue jack **(14)** is connected to internal ground (see also **(22)**). The “opposite” side of the Peltier element is connected here (see also chapter 3.5).

POWER OUTPUT is also available at the SENSOR A **(18)** and SENSOR B connectors **(16)** for devices with the ALA DIN cable assembly.

Note: It is not recommended to use jack **(14)** for grounding purposes. Use instead GROUND / PROTECTIVE EARTH connectors **(22)** or **(23)** to ground your system.

(15) OUTPUT B 10mV/°C connector

BNC connector monitoring the temperature determined by SENSOR B **(16)**, sensitivity: $10\text{mV} / ^\circ\text{C}$.

(19) OUTPUT A 10mV/°C connector

BNC connector monitoring the temperature determined by SENSOR A **(18)**, sensitivity: $10\text{mV} / ^\circ\text{C}$.

(21) COMMAND INPUT 10mV/°C connector

BNC connector to set the working temperature of the controller system by an external voltage signal. This input is scaled with the factor $10\text{mV} / ^\circ\text{C}$.

(22) GROUND / (23) Protective earth connectors

To avoid ground loops the internal ground of the system is floating, i.e. it is not connected to the protective earth of the line cable while the cabinet is always connected via the power supply cable (green / yellow wire). The system can be grounded by connecting plug **(22)** internal ground or **(23)** protective earth.

(24) POWER pressure switch

Switch to turn POWER on (switch pushed) or off (switch released).

3.3. Rear Panel Elements

LINE VOLTAGE SELECTION: The selector for the line voltage and the connector for the power cord are located in a mains connection module on the rear panel of the instrument.

FUSE: The fuse is also integrated in the mains connection module. The line fuse must be 4 A slow (115 V) or 2 A slow(230 V). It must be replaced only by specified type (see above). Always disconnect mains power plug when replacing fuse.

Caution: The instrument may be damaged if the wrong line fuse is installed!

3.4. Electronic Control and Protection Circuits

CONTROL LOOP

The sensor / thermometer, PI-controller, output power stage and Peltier element form a closed loop control system. The desired temperature signal is compared with the output signal obtained from the thermometer giving an error signal. This signal is amplified in the PI controller and transferred to the output stage where it is converted to a high-power output signal applied to the Peltier element.

ELECTRONIC PROTECTION CIRCUITS

Each system is equipped with two protection systems:

1. Sensor inputs: an electronic shut-off function disconnects the output if the sensor is disconnected, broken or short-circuited.
2. Output protection: the output current and voltage are limited electronically.

Important: The sensor used for the control must be in good thermal connection with the Peltier element, if not, unstable operation and damage may occur.

ALARM CIRCUIT

The internal thermometer (R2252 or PT 100 sensor) inputs are protected by the sensor alarm circuit (see above). If this thermometer is used as input for the PI controller, the ALARM circuit disconnects the power output if the sensor is damaged, not connected or if the measured temperature goes beyond the shutoff temperature (see also 24, Figure 1). This status is indicated by the red ALARM LED.

Important: In DIRECT or EXT. SENSOR mode the ALARM circuit is disabled!!

ACCURACY

Measuring accuracy of the internal thermometer is 0.1 °C, controller accuracy is 0.5 °C or better (depending on the amount of heated solution).

3.5. Connection of Peltier Elements

The PTC-10 is designed to work with Peltier elements. Peltier elements have two different sides: one is the “active” side and the other is the “opposite” side (usually marked as “active” and “opposite” respectively). In order to work properly the Peltier elements have to be connected with right polarity to the PTC-10.

Quick installation:

- Connect the “active” side to the + pole (**13**, Figure 1)
- Connect the “opposite” side to the - pole (**14**, Figure 1)
- Mount the Peltier element on a heat sink (the “opposite” side facing the heat sink)
This is very important especially if you use the Peltier element for cooling, because in this mode the “opposite” side gets hot!!

or

- Connect a Peltier element using an ALA DIN cable to one of the SENSOR connectors (**16**, **18**, Figure 1). The right polarity is ensured automatically.

Now it is ensured that the “active” side gets hot if the MODE switch (**5**, Figure 1) is set to HEAT and cold if the MODE switch (**5**, Figure 1) is set to COOL in DIRECT mode. The right polarity is also very important for all other operation modes (see chapter 3.6).

Note: The POWER OUTPUT lines of the SENSOR connectors are always connected, regardless of the MODE OF OPERATION (see chapter 3.6).

3.6. Modes of Operation

The system can be used in the following modes of operation:

- DIRECT MODE: output voltage is set directly by the DESIRED TEMP. °C control.
- Internal SENSOR mode: output voltage is controlled by the PI controller using SENSOR A or SENSOR B.
- EXT. SENSOR mode: output voltage is controlled by the PI controller using an external thermometer.

DIRECT Mode

In DIRECT mode (no temperature control) the MODE switch (**5**, Figure 1) is switched to one of the two possible DIRECT positions:

DIRECT HEAT position sets the output voltage positive (referring to ground).

DIRECT COOL position sets the output voltage negative (referring to ground).

In both DIRECT modes the control unit is not active, i.e. the output voltage is preset directly by the DESIRED TEMP. °C control (**2**, Figure 1). With setting from 000 to 999 the output voltage increases from 0 V to +12 V (DIRECT HEAT) or 0 V to -12 V (DIRECT COOL).

Note: The ALARM circuit (see below) is disabled in this mode.

Note: In DIRECT COOL mode there will not be any output voltage when the HEAT ONLY toggle switch is activated!
DIRECT HEAT and DIRECT COOL will work in this way only if the Peltier element is connected to the PTC-10 with right polarity!

HEATING / COOLING OPERATION in DIRECT mode

The PTC system is designed with bipolar outputs (0 V to ± 12 Volt DC). If a resistive load is used, the system can be used for heating purposes in all modes (CONTROL and DIRECT). If a PELTIER device is connected to the output, the system can be used either for heating purposes or for cooling ("active" side of the Peltier device in contact with recording chamber). If a Peltier device is used for cooling purposes, the "opposite" side of the Peltier element must be connected to an adequate heat sink.

Caution: When using COOL DIRECT mode check the position of the HEAT ONLY toggle switch (position is also indicated by the red HEAT ONLY LED). In any case cooling function is only possible when this switch is not activated!

Internal SENSOR mode

In this mode the output voltage is controlled by the PI controller (PI [proportional-integral controller system] activated).

The SENSOR position selects the internal thermometer which use a small semiconductor or PT100 sensor. The measured temperature is displayed at the respective digital display unit (3 or 7, Figure 1). The selected SENSOR input (A or B) is connected to the controller and output stage.

If no sensor is connected, or if the sensor is damaged or short circuited, or the measured temperature goes beyond the shutoff temperature (see also 24, Figure 1), the internal shut-off unit disconnects the corresponding power output. This state is indicated by the red ALARM LED (4 or 6, Figure 1).

EXT. SENSOR mode

This mode can be used to connect an external thermometer. The calibration of the external input BNC (17, Figure 1) is $1 \text{ mV} / ^\circ\text{C}$. If this option is used the internal ALARM circuit is disabled.

Note: The ALARM circuit (see below) is disabled in this mode.

Figure 5 gives an overview of the operation modes of the PTC-10.

3.7. Setting the *DESIRED TEMPERATURE*

There are two ways to set the *DESIRED TEMPERATURE*:

1. The easiest way is to use the digital potentiometer *DESIRED TEMP. / °C*. The temperature can be set from +03.0 °C to +60.0 °C, resolution: 0.1 °C. If the PTC-10 leaves this temperature window the internal shut-off unit disconnects the power output. This could also be the case if the sensor is broken or short-circuited.
2. If the user wants to have external control (e.g. with a computer system) the *DESIRED TEMPERATURE* can be set using the *COMMAND INPUT 10mV / °C* connector (10, Figure 1). The *COMMAND INPUT* is scaled 10mV / °C, i.e. +370 mV at this connector would set the *DESIRED TEMPERATURE* to +37 °C.

Important: The set value of the temperature is always the sum of the setting at *DESIRED TEMP. / °C* potentiometer and the voltage at *COMMAND INPUT 10mV / °C* connector, i.e. if *DESIRED TEMP. / °C* is set to +25.0 °C and the voltage at *COMMAND INPUT 10mV / °C* is +150 mV the temperature will be set to +40 °C !!

4. Grounding

To avoid ground loops, the internal ground of the system is floating, i.e. it is not connected to the protective earth of the mains while the cabinet is always connected to protective earth (green / yellow wire). The system can be grounded either via a BNC cable connected to *INPUT* or *OUTPUT (10 mV / °C)* or via the blue *OUTPUT (= GND)* connector.

5. Temperature sensors / Block diagram

5.1. DIN Connector

Cable of temperature sensor for PTC / MTC / TC

length : 2m

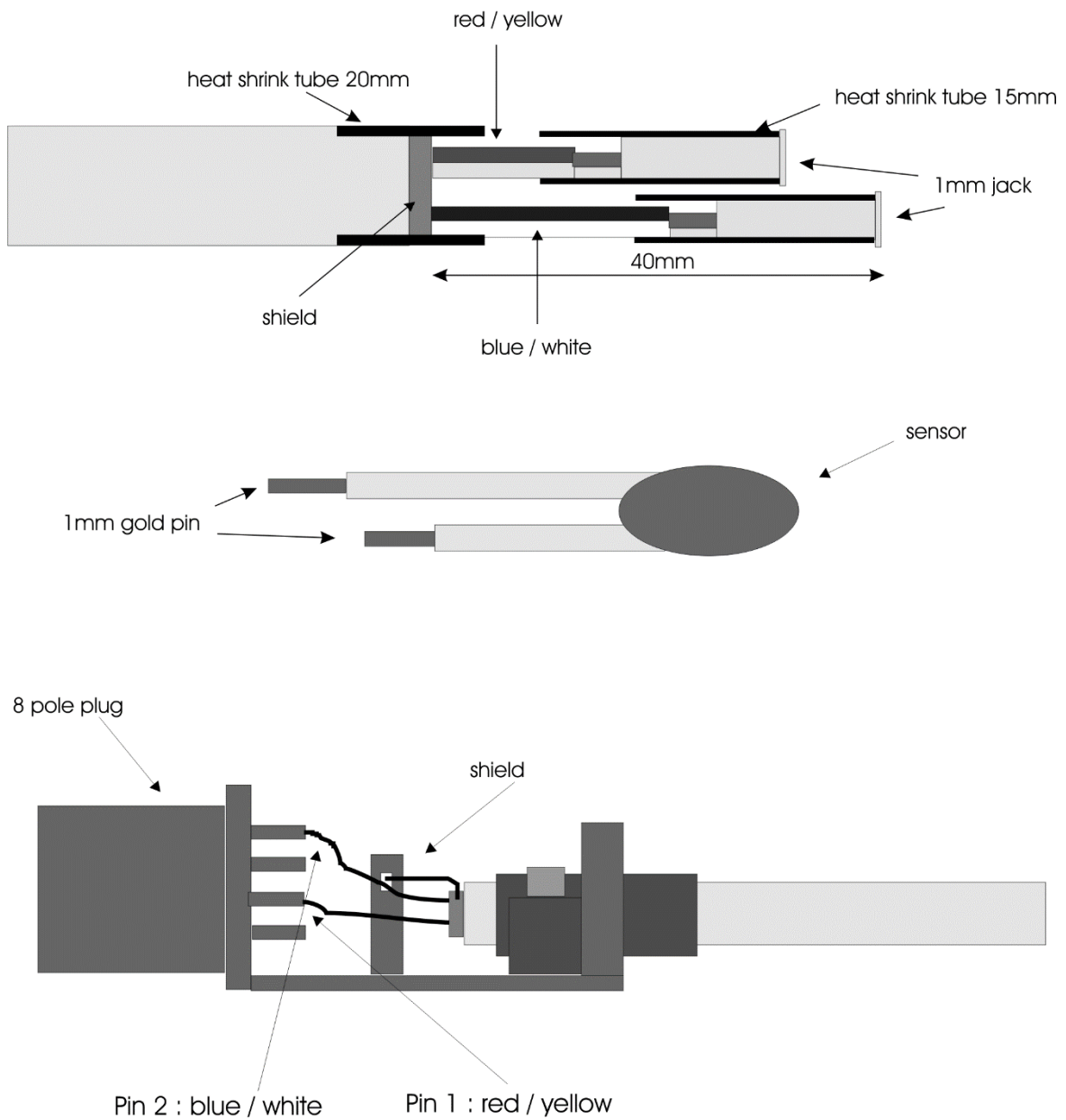

Figure 2: How to connect the temperature sensor

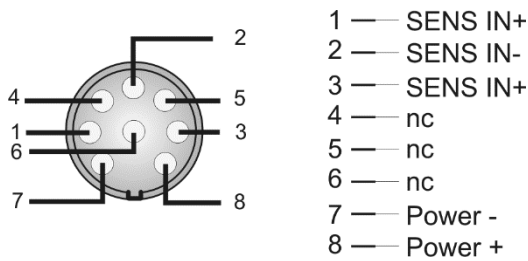

Figure 3: Connector pinout of the DIN connector (pins 1 and 3 are connected internally)

5.1. Available sensors



Figure 4: Temperature sensors and cable.

The sensors come with a connection cable (TS-CAB, see Figure 4, left) with a DIN connector on one end and two 1 mm connectors on the other end. The DIN connector is for connection to the SENSOR input at the front panel of the temperature controller. The 1 mm connector are for connection of the sensor, which is available as spare part.

There are two sensors available: the white TS-100S (Figure 4right, top) and the dark TS-200S (Figure 4 right, bottom).

Important: The TS-100S has a special coating that makes it mechanically stable and waterproof. The TS-200S is optimized for size. Its coating might get leaky after mechanical stress (e.g. bending of the wires).

Dimensions:

TS-100S: 2.5 mm x 6 mm

TS-200S: 0.8 mm x 6 mm

5.2. Block diagram

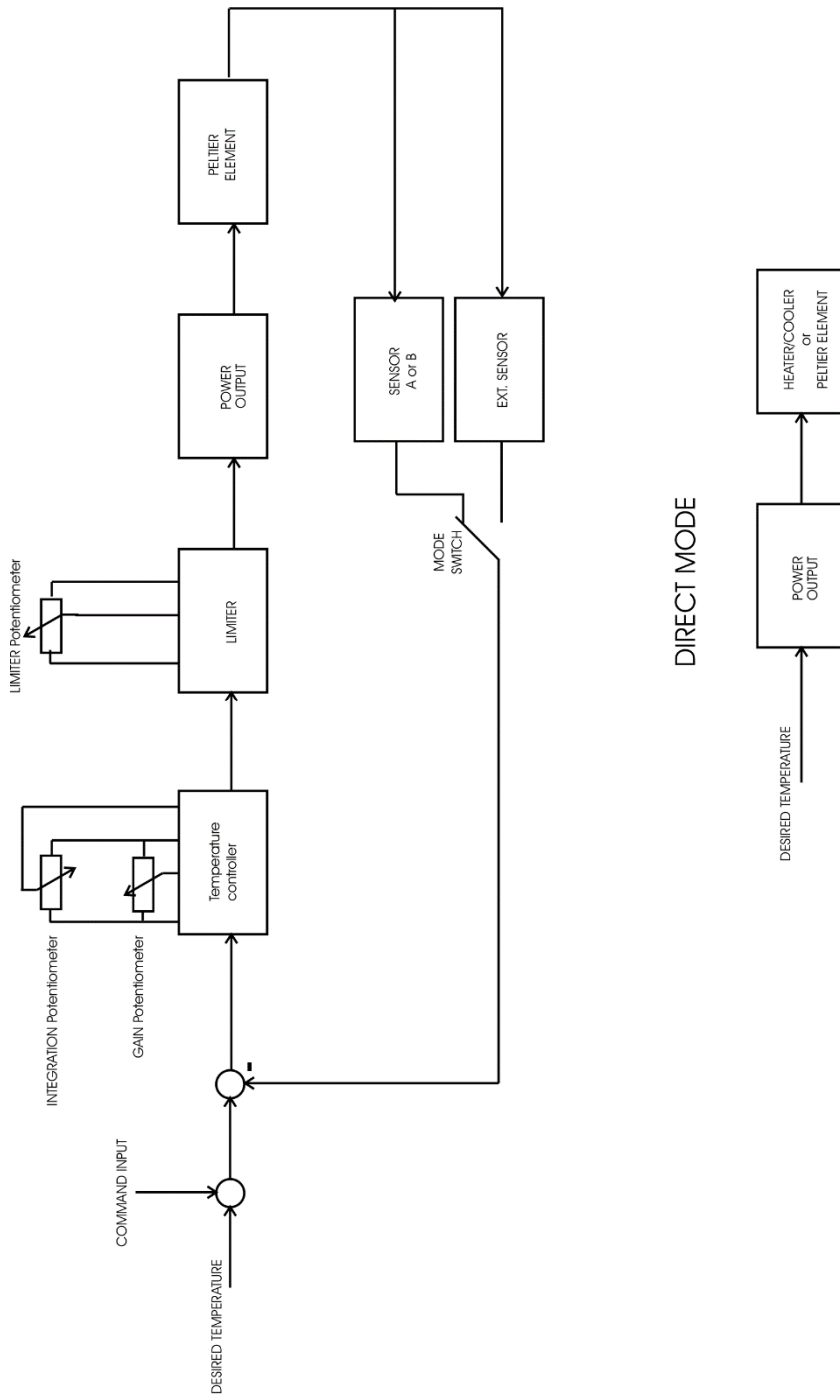

Figure 5: Block diagram of the PTC-10

6. Operating guide – Tuning procedure

After unpacking the instrument please check the appropriate voltage at the voltage selector at the back panel. Also check that the sensor used for the control is in good thermal connection with the heating wire or the “active” side of the Peltier element and that the Peltier element is connected with right polarity (see chapter 3.5).

Important: Make sure that the SENSOR or the external SENSOR, respectively, and the heating device / Peltier element that is controlled by this SENSOR are using the same channel. Otherwise the heating device/ Peltier element may be damaged due to overheating.

In the following it is assumed that you use devices delivered by npj or ALA Scientific Instr. with 12V operating voltage. Please follow these instructions step by step to avoid problems in adjusting the instrument.

- Turn all potentiometers to the most left position
- switch the MODE selector to the position SENSOR A or B depending on which sensor is used as feedback temperature in the controller loop
- set the DESIRED TEMPERATURE to e.g. 37 °C

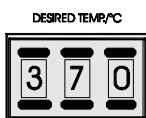

turn on the instrument and wait at least 15 minutes to warm up the instrument. The temperature display should show the actual temperature at the sensor

- turn the LIMITER to 100%

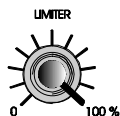

Note: If you use heating wires with 6V operating voltage turn the LIMITER to 50% to protect the wire from damage.

If the difference between the actual and the desired temperature is more than 10 °C the HEAT-LED will light up slightly.

- turn the GAIN to the seventh scale mark



The actual temperature at the sensor now approaches the desired temperature but will not reach 37 °C, because the control loop is not yet well adjusted. The actual temperature will arrest at 1 to 2 °C below the desired temperature. Please wait until this steady state value is reached. This may last several minutes. If you don't get a steady state value, set the LIMITER to 80-90% (or 30-40%, respectively) and wait again.

- Now turn on the INTEGRATION and set it approximately to the first scale mark. You will hear a “Click” if the INTEGRATION gets active.



The actual temperature at the sensor will now reach the desired temperature possibly after a small overshoot. Wait again until the steady state value is reached. If this value is not reached set the GAIN to higher levels until - in this example - 35 °C to 35.5 °C is reached.

- If the desired temperature is not reached first set the GAIN to a slightly higher level and then – if necessary – raise the INTEGRATION (see Figure 6).

Note: The speed of the control circuit (and therefore the time in which the actual temperature reaches the DESIRED TEMPERATURE) is highly dependent on the first settings of GAIN and INTEGRATION. Thus, when beginning to use the PTC-10 we recommend to try out several first settings of GAIN and INTEGRATION to find out which settings are best for your experimental conditions.

If you use a perfusion system and you are going to heat it is recommended to heat the solution approximately to the desired temperature **before** perfusing the bath either with a heated perfusion tube (HPT-2A, available from npi) or by heating up the supplying bowl.

As mentioned above it is very important that the sensor element and the heating / cooling element are in good thermal connection.

In Figure 6 the time course of temperature regulation of the PTC-10 is shown. As resistive load a bulb (12V, 21W) was used. The temperature sensor was fixed directly on the bulb and sensor and bulb were wrapped with foam. Starting temperature was 27,3 °C. Starting conditions were: LIMITER set to 0, GAIN set to 0, INTEGRATION off.

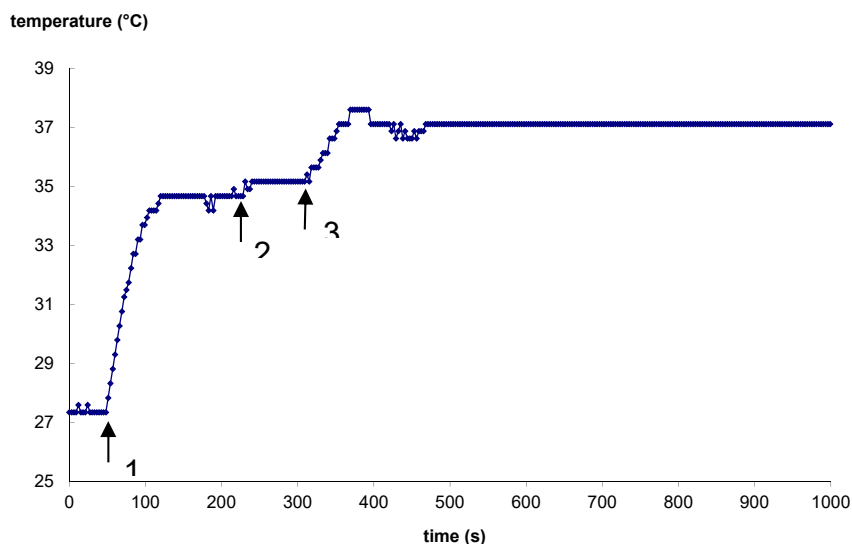

Figure 6: Time course of temperature regulation of the PTC-10.

- 1: LIMITER was set to 100%, GAIN was set to the seventh scale mark
- 2: GAIN was set to the eighth scale mark
- 3: INTEGRATION was turned on at a low level

6.1. PTC-10 and the HCMIS Micro-Incubator

Connection

Connect the HCMIS using the ALA DIN cable to one of the SENSOR connectors (16, 18, Figure 1). The right polarity is ensured automatically.

Operation

Heating

Follow the steps as described above. With the HCMIS micro-incubator from ALA Scientific Instr. it is likely that you have to use more gain in order to reach a steady state temperature of 35 °C to 36 °C without INTEGRATION. In that case increase the gain stepwise and wait in every step until the temperature reaches a steady state level of 35 °C to 36 °C and then turn on the INTEGRATION as described above (see also Figure 7).

Cooling

It is characteristic for Peltier elements that when they cool on one side the other side gets very hot. When cooling the upper side of the HCMIS gets hot and it must be ensured that the heat from the upper side is carried off. This is best done by using the fluid cooling system of the HCMIS. Without cooling the HCMIS with fluid it is not possible to reach temperatures below 20 °C.

Caution: When operating the HCMIS in cooling mode always use the fluid cooling system to avoid overheating and damage of the Peltier elements. These systems are available from ALA Scientific Instruments. Please ask npi.

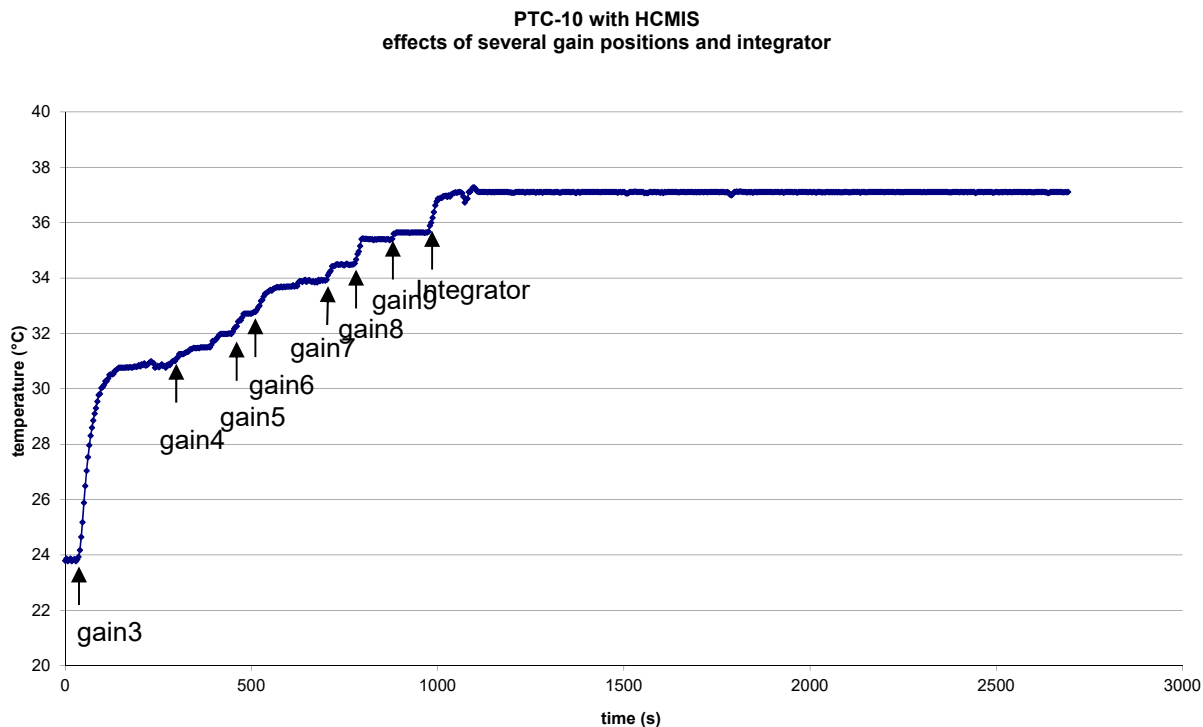

Figure 7: Time course of temperature regulation of the PTC-10, HCMIS micro-incubator connected

6.2. Operation with HPT-2A heated perfusion tube (discontinued)

For use with HPT-2A from ALA please follow these hints.

- Always use the LIMITER. Do not set the LIMITER to more than 30% for a longer time, since the HPT-2A will melt if operated at more than 5V. If in doubt, measure the output voltage using a voltmeter.
- Do not heat the HPT-2A without flow of solution. See also HPT-2A manual.

7. Literature

Kettenmann, H. and R. Grantyn (eds.) Practical Electrophysiological Methods, Wiley-Liss, New York 1992

Froehr, F. and F. Ortttenburger Introduction to Electronic Control Engineering, Siemens AG, Berlin and Munich 1982

8. Technical Data

<u>Sensor input:</u>	for semiconductor 2252 Ω at 25 °C (standard) or platinum 100 Ω at 0 °C, accuracy typically 0.1 °C at 25 °C, with electronic protection
<u>Sensor input (EXT. Mode):</u>	1mV / °C
<u>ALARM and SHUTOFF:</u>	disconnects POWER OUTPUT if temperature is below +3 °C (not connected or broken sensor) or above +60 °C (short circuited sensor), other ranges possible NOT in EXT.SENSOR or DIRECT mode
<u>Digital displays:</u>	3 1/2 digits, XX.X °C (temperature of SENSOR A or B) or XX.X V (voltage at power output)
<u>COMMAND INPUT:</u>	analog input, 10mV / °C, via BNC connector
<u>Set value control:</u>	digital control, range: 03.0 °C to 60.0 °C (other value possible), XX.X °C or 0-100% of output voltage (DIRECT modes)
<u>Temperature OUTPUT (A, B):</u>	analog outputs, 10mV / °C, via BNC connector, output impedance: 250 Ω
<u>Power output:</u>	± 12 V / 3.5 A continuous, ± 12 V / 5 A peak, short circuit protected, continuous DC, ± 15 V on request
<u>Limiter:</u>	control for the output voltage with a linear range from 0 – 100 %
<u>Control:</u>	PI (proportional-integral) controller, accuracy typically ± 0.2 °C, gain range 10 - 10k, integration time 50 ms - 20 s (logarithmic scale)
<u>Measuring accuracy:</u>	0.1 °C at 25 °C
<u>Power requirements:</u>	115V / 230V AC, 60 / 50 Hz, fuse 4 A / 2 A slow
<u>Dimensions:</u>	19" rackmount cabinet 19" (483 mm), 10" (250 mm), 3.5" (88 mm)